

DUO  
z podnóżkiem

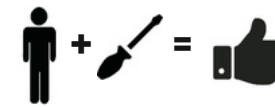

🕒 10min.

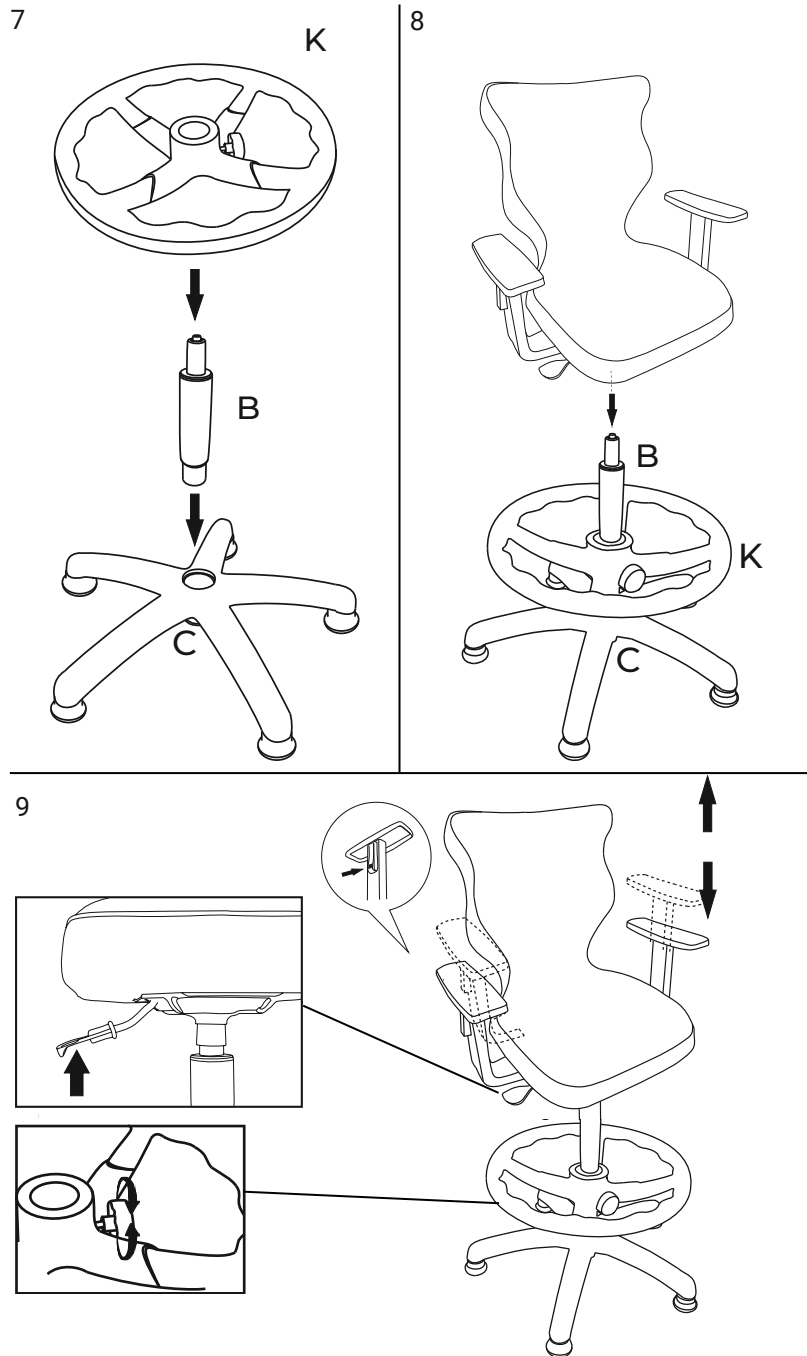

A  1x	B  1x	C  1x	D  5x	E  2x	
F  4x M6X14	G  4x M6X30	H  2x M6X40	I  2x	J  1x	K  1x
L  1x	M  1x	F G H			

1

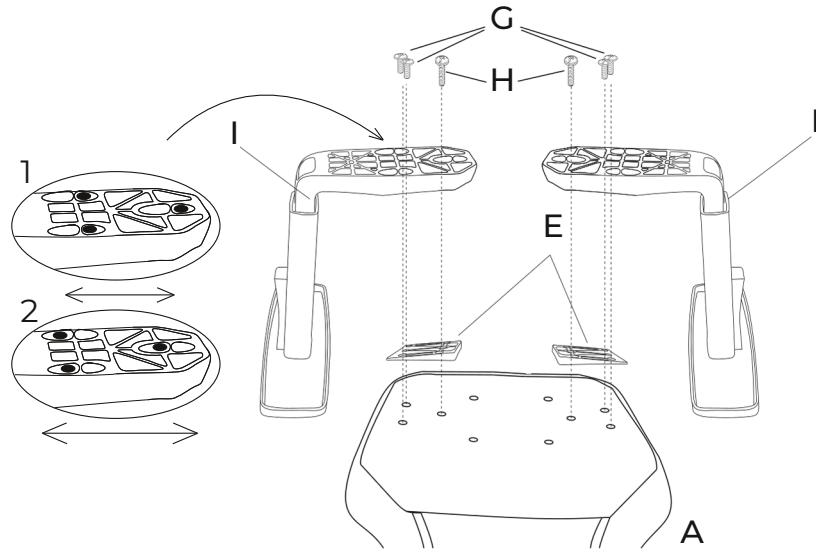

4

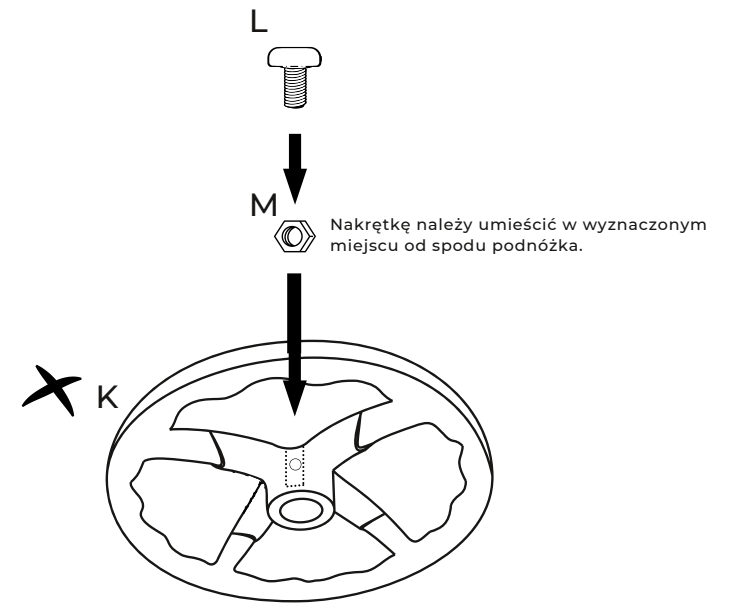

2

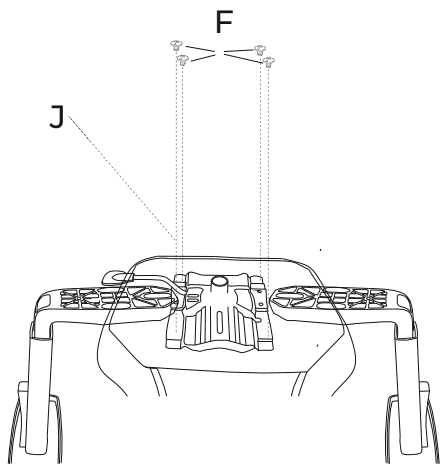

3

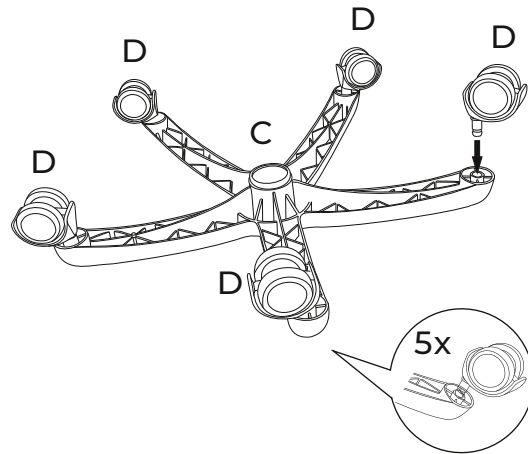

5

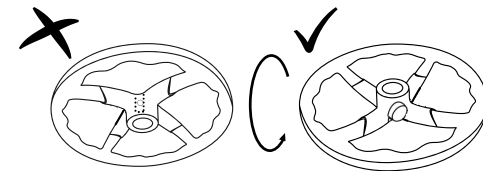

6

